

THIS DOCUMENT CONTAINS DATA PROPRIETARY TO PROJECTS UNLIMITED, INC. ANY USE OR REPRODUCTION, IN ANY FORM, WITHOUT PRIOR WRITTEN PERMISSION OF PROJECTS UNLIMITED, INC. IS PROHIBITED.
 © 2005, Projects Unlimited Inc.

SPECIFICATIONS

PARAMETERS	VALUES	UNITS
DIRECTIVITY	OMNIDIRECTIONAL	—
SENSITIVITY	-46±3	dB
STANDARD OPERATING VOLTAGE	1.5	Vdc
MAX OPERATING VOLTAGE	10	Vdc
CURRENT CONSUMPTION (MAX)	0.5	mA
IMPEDANCE	2.2	kOhm
SIGNAL TO NOISE RATIO (MIN.)	60	dB
TERMINAL	PIN	—
INTERNAL CAPACITOR	N/A	pF

REVISIONS			
LTR	DESCRIPTION	DATE	APPROVED
—	RELEASED FROM ENGINEERING	1/5/06	

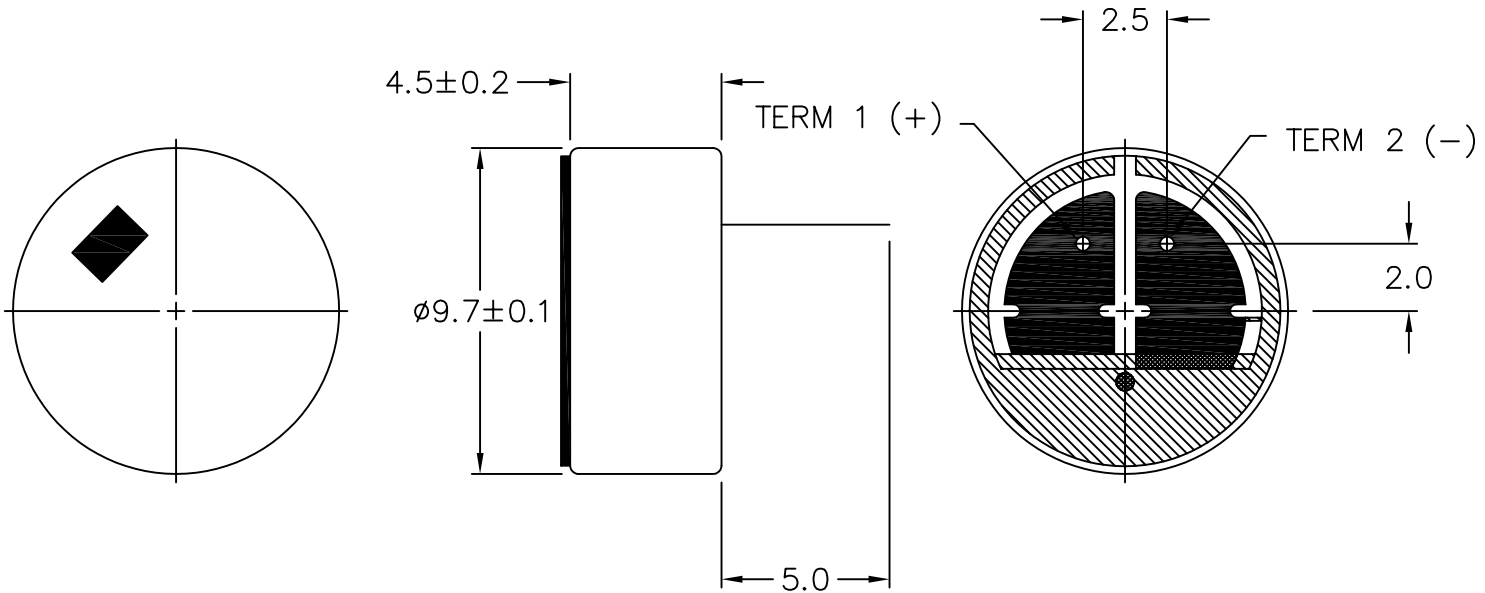

NOTES:

1. ALL DIMENSIONS ARE IN MILLIMETERS.
2. SPECIFICATION SUBJECT TO CHANGE OR WITHDRAWAL WITHOUT NOTICE.
3. THIS PART IS RoHS 2002/95/EC COMPLIANT.

FILE NAME
AOM-4546P-R.DWG

UNLESS OTHERWISE SPECIFIED:
DIMENSIONS ARE IN MILLIMETERS, TOLERANCES ARE ± 0.5 AND ANGLES ARE $\pm 3^\circ$.

 projects® unlimited Dayton, Ohio

APPROVALS	DATE
DRAWN <i>J.A.F.</i>	01/06
CHECKED <i>E.P.</i>	01/06
APPROVED <i>B.R.</i>	01/06

SIZE
A

MICROPHONE

DRAWING NO.
AOM-4546P-R

DO NOT SCALE DRAWING

SCALE: N.T.S.

SHEET 1 OF 1